 Grip Factory Munich GmbH Fürholzener Straße 1 85386 Eching bei München Germany Tel: +49 (0) 89 319 01 290 Fax: +49 (0) 89 319 01 299 www.g-f-m.net	GF - 16 Version 1					
		Name	Datum	Index	Datum	Zeichnungsnummer
	Gez.	Trautwig	11.08.01	d	14.10.03	200-000-01e
Gepr.			e	07.03.05		

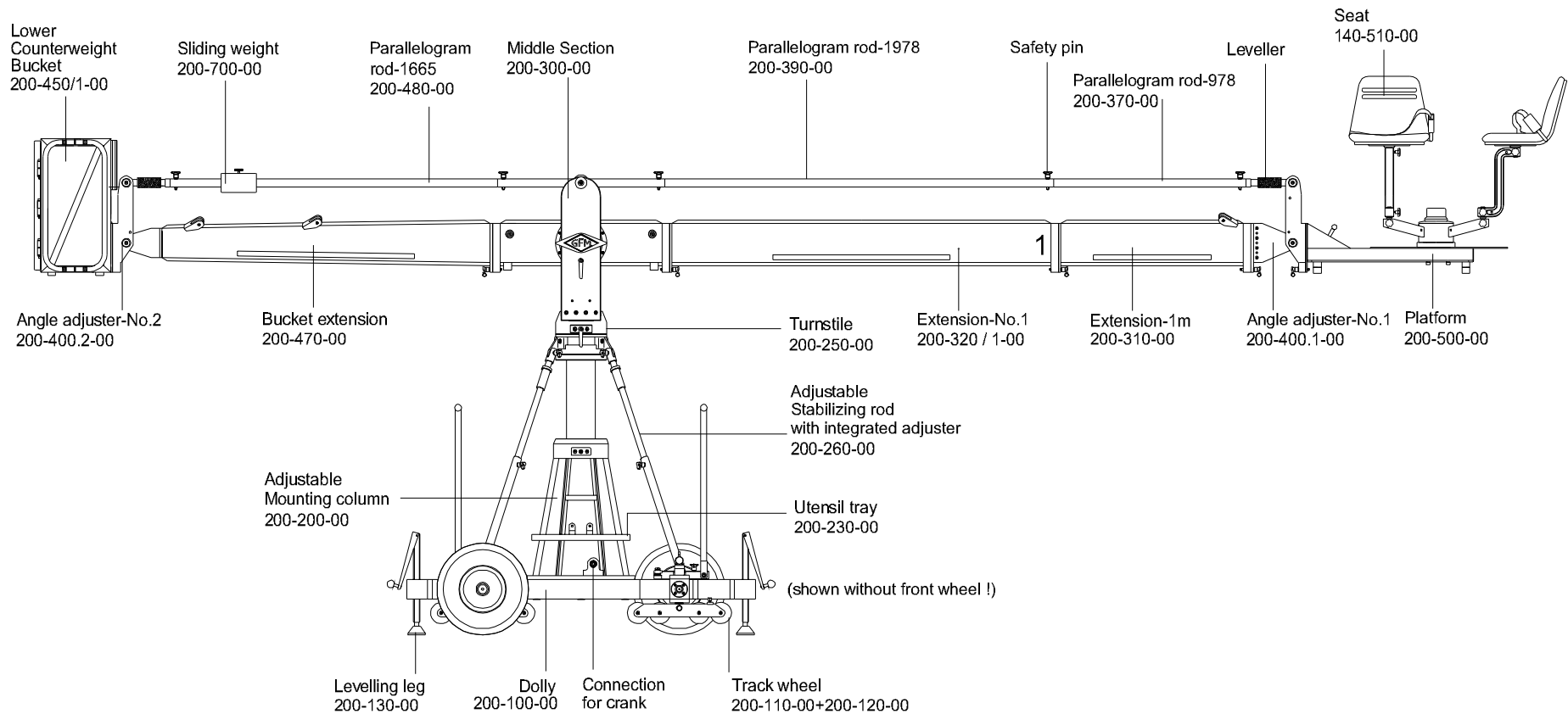

Grip Factory
Munich GmbH

Fürholzener Straße 1
85386 Eching bei München
Germany

Tel: +49 (0) 89 319 01 290
Fax: +49 (0) 89 319 01 299
www.gfm.net

GF - 16 Version 2

Name	Datum	Index	Datum	Zeichnungsnummer
Gez. Trautwig	11.03.01	d	14.10.03	200-000-02e
Gepr.		e	14.10.03	

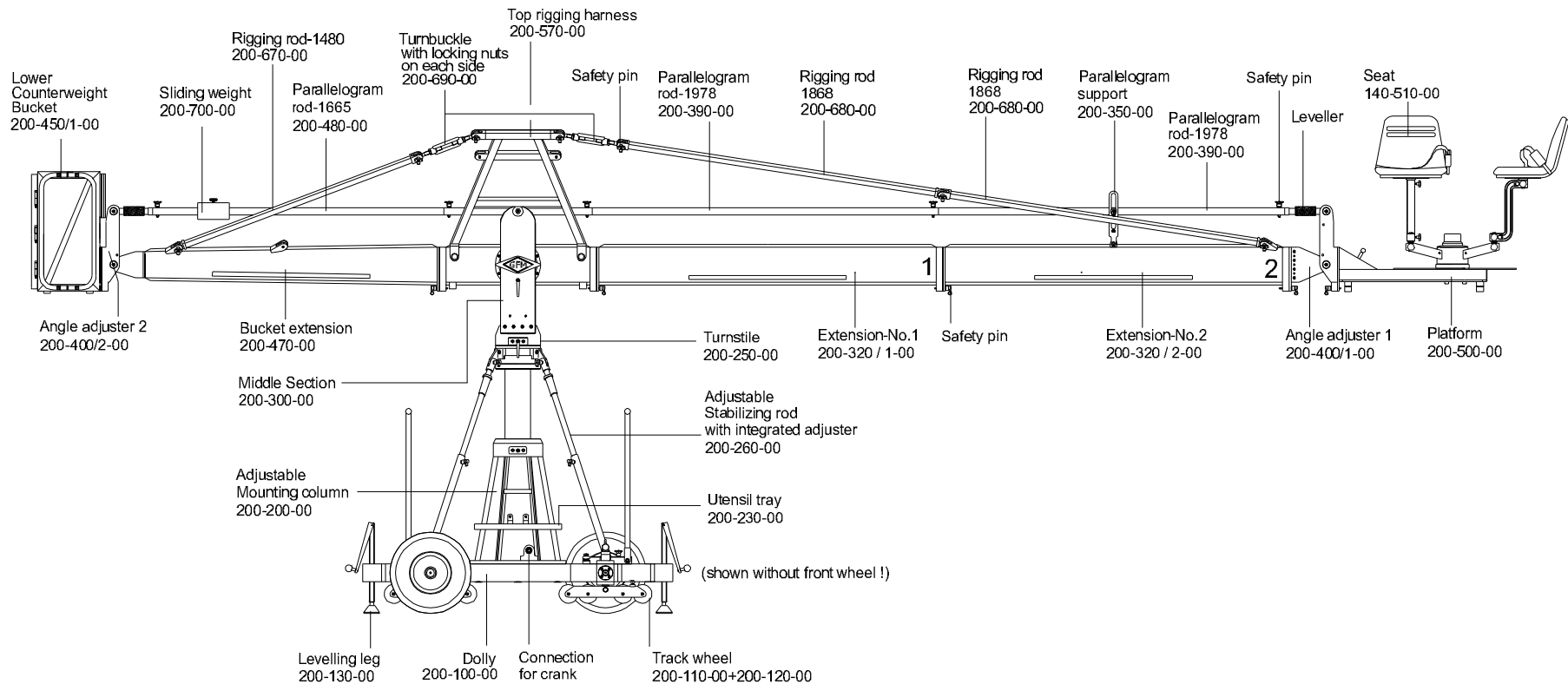

Grip Factory
Munich GmbH

Fürholzener Straße 1
85386 Eching bei München
Germany

Tel: +49 (0) 89 319 01 290
Fax: +49 (0) 89 319 01 299
www.gfm.net

GF - 16 Version 3

Name	Datum	Index	Datum	Zeichnungsnummer
Gez. Trautwig	23.01.02	e	14.10.03	200-000-03f
Gepr.		f	07.03.05	

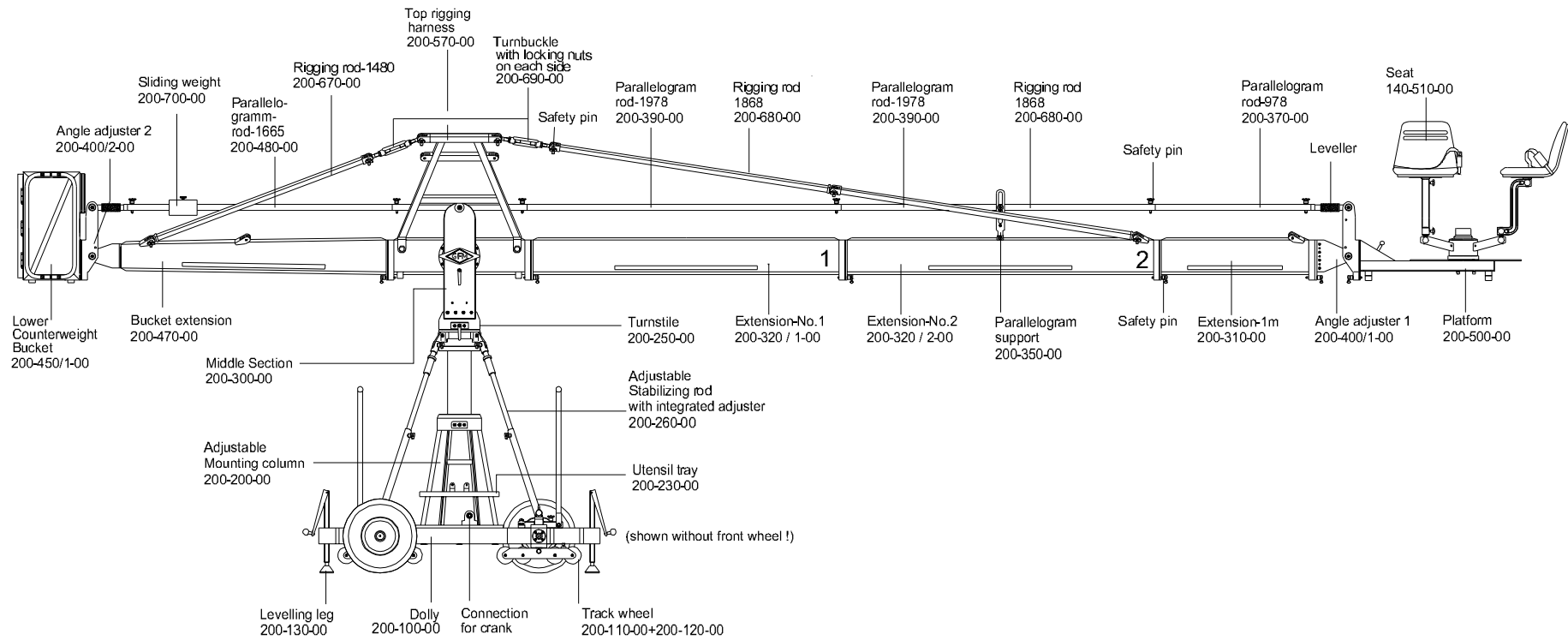

Grip Factory
Munich GmbH

Fürholzener Straße 1
85386 Eching bei München
Germany

Tel: +49 (0) 89 319 01 290
Fax: +49 (0) 89 319 01 299
www.gfm.net

GF - 16 Version 4

Name	Datum	Index	Datum	Zeichnungsnummer
Gez. Trautwig	22.01.02	e	22.09.03	200-000-04f
Gepr.		f	14.10.03	

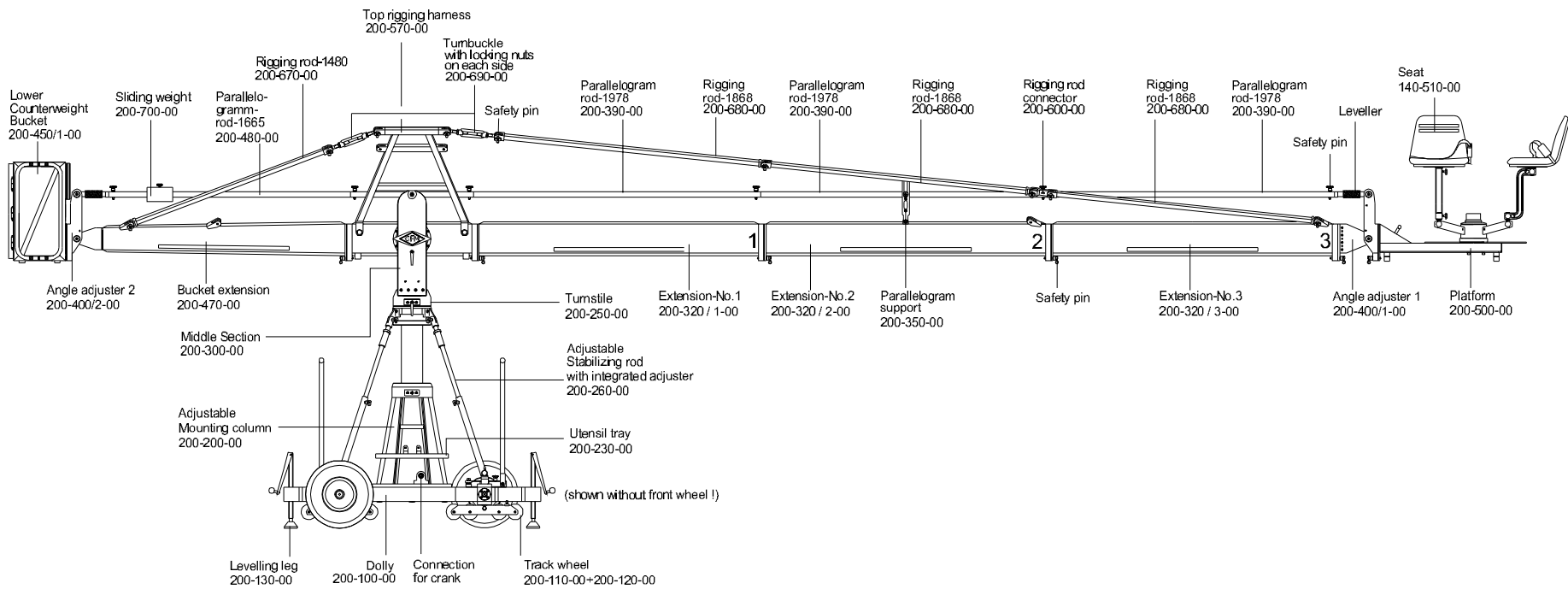

Grip Factory
Munich GmbH

Fürholzener Straße 1
85386 Eching bei München
Germany

Tel: +49 (0) 89 319 01 290
Fax: +49 (0) 89 319 01 299
www.gfm.net

GF - 16 Version 5

Name	Datum	Index	Datum	Z	Zeichnungsnummer
Gez. Trautwig	23.01.02	e	14.10.03		200-000-05e
Gepr.		f	07.03.06		

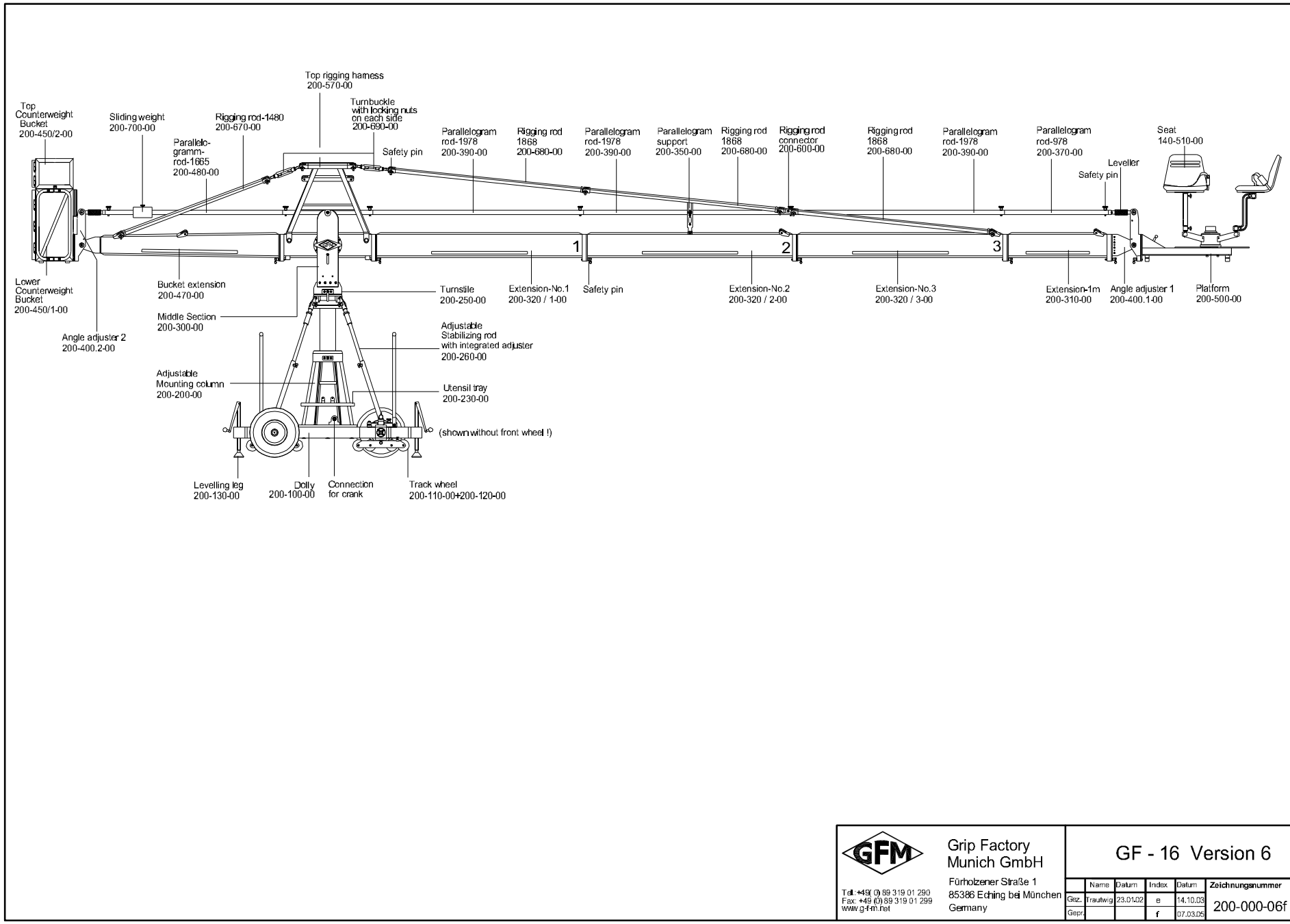

Grip Factory
Munich GmbH

Fürholzener Straße 1
85386 Eching bei München
Germany

Tel: +49 (0) 89 319 01 290
Fax: +49 (0) 89 319 01 299
www.gfm.net

GF - 16 Version 6

Name	Datum	Index	Datum	Zeichnungsnummer
Gez. Trautwig	23.01.02	e	14.10.03	200-000-06f
Gepr.		f	07.03.06	

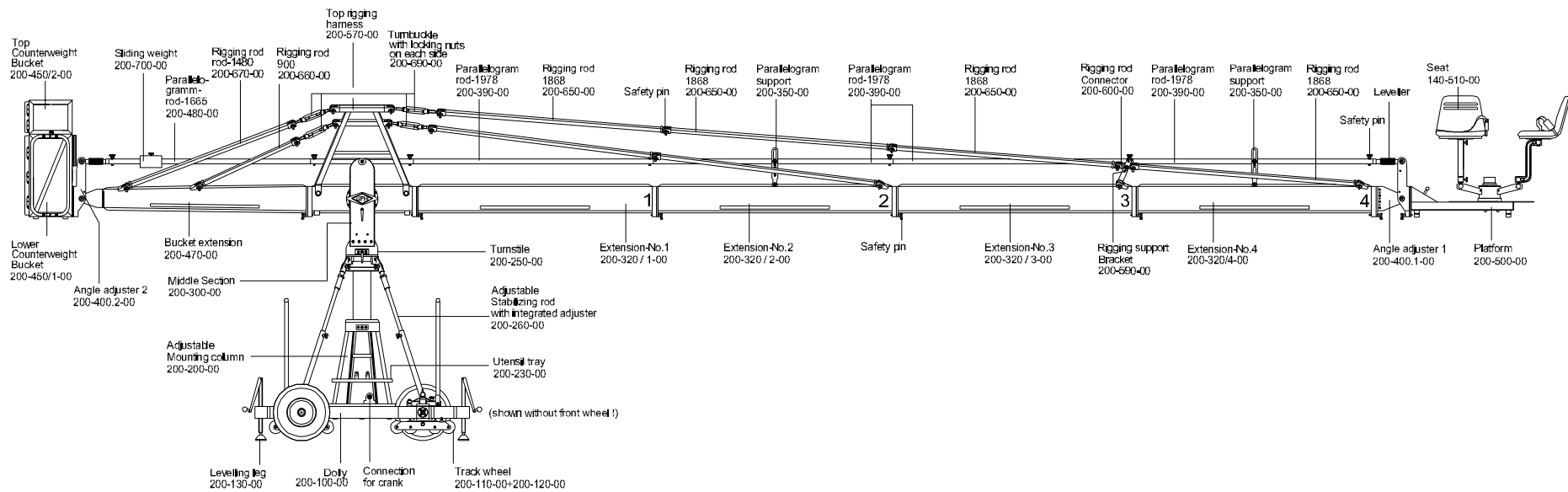

Grip Factory
Munich GmbH

Fürholzener Straße 1
85386 Eching bei München
Germany

Tel: +49 (0) 89 319 01 290
Fax: +49 (0) 89 319 01 299
www.g-f-m.net

GF - 16 Version 7

Name	Datum	Index	Datum	Zeichnungsnummer
Gez. Trautwig	23.01.02	e	14.10.03	200-000-07f
Gepr.		f	07.03.05	

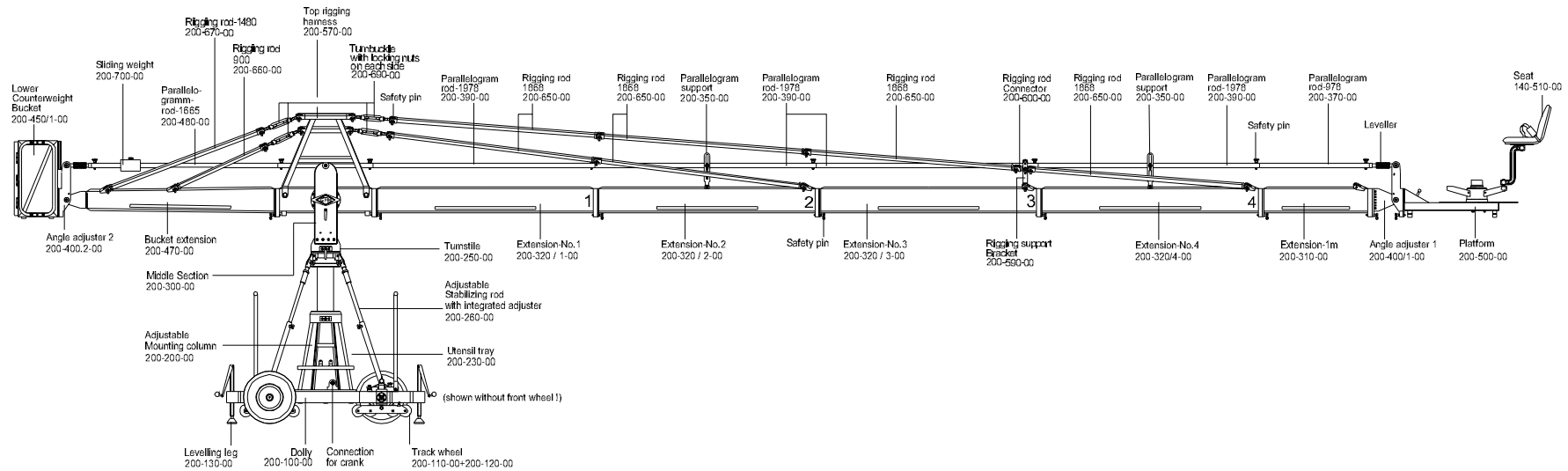

Grip Factory
Munich GmbH

Fürholzener Straße 1
85386 Eching bei München
Germany

Tel: +49 (0) 89 319 01 290
Fax: +49 (0) 89 319 01 299
www.g-f-m.net

GF - 16 Version 8

Name	Datum	Index	Datum	Zeichnungsnummer
Gez. Trautwig	23.01.02	e	14.10.03	200-000-08f
Gepr.		f	07.03.06	

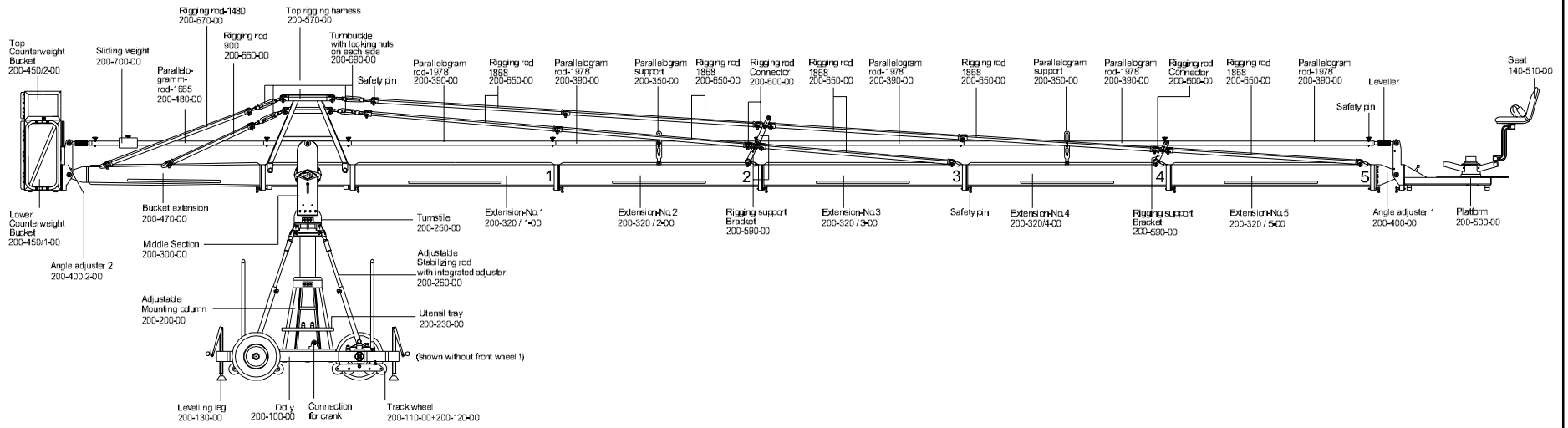

Grip Factory
Munich GmbH

Fürholzener Straße 1
85386 Eching bei München
Germany

Tel: +49 (0) 89 319 01 290
Fax: +49 (0) 89 319 01 299
www.g-f-m.net

GF - 16 Version 9

Name	Datum	Index	Datum	Zeichnungsnummer
Gez. Trautwig	23.01.02	e	14.10.03	200-000-09f
Gepr.		f	07.03.06	

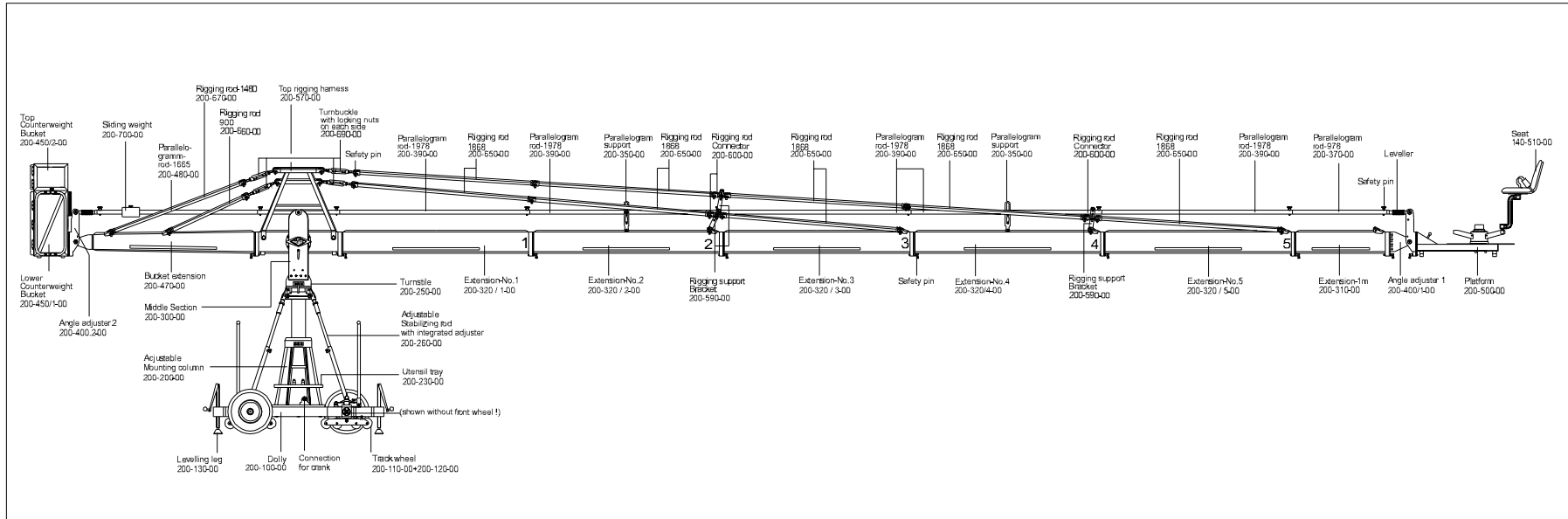

Grip Factory
Munich GmbH

Fürholzener Straße 1
85386 Eching bei München
Germany

Tel: +49 (0) 89 319 01 290
Fax: +49 (0) 89 319 01 299
www.g-f-m.net

GF - 16 Version 10

Name	Datum	Index	Datum	Zeichnungsnummer
Gez. Trautwig	23.01.02	e	14.10.03	200-000-10f
Gepr.		f	07.03.06	

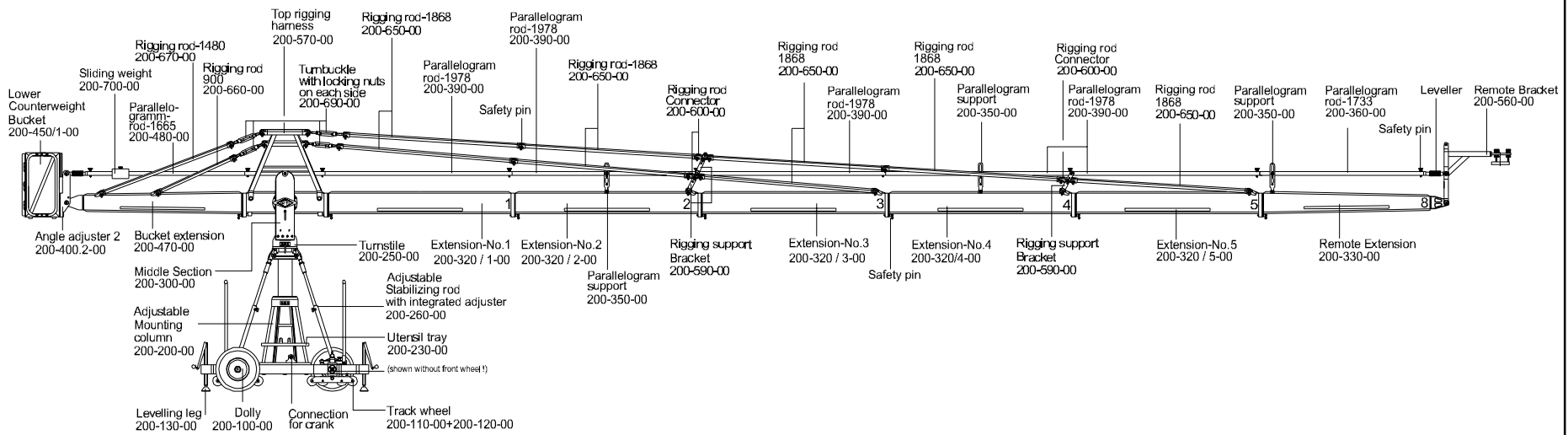

Grip Factory
Munich GmbH

Fürholzener Straße 1
85386 Eching bei München
Germany

Tel: +49 (0) 89 319 01 290
Fax: +49 (0) 89 319 01 299
www.gfm.net

GF - 16 Version 11

Name	Datum	Index	Datum	Zeichnungsnummer
Gez. Trautwig	23.01.02	e	14.10.03	200-000-11f
Gepr.		f	07.03.05	

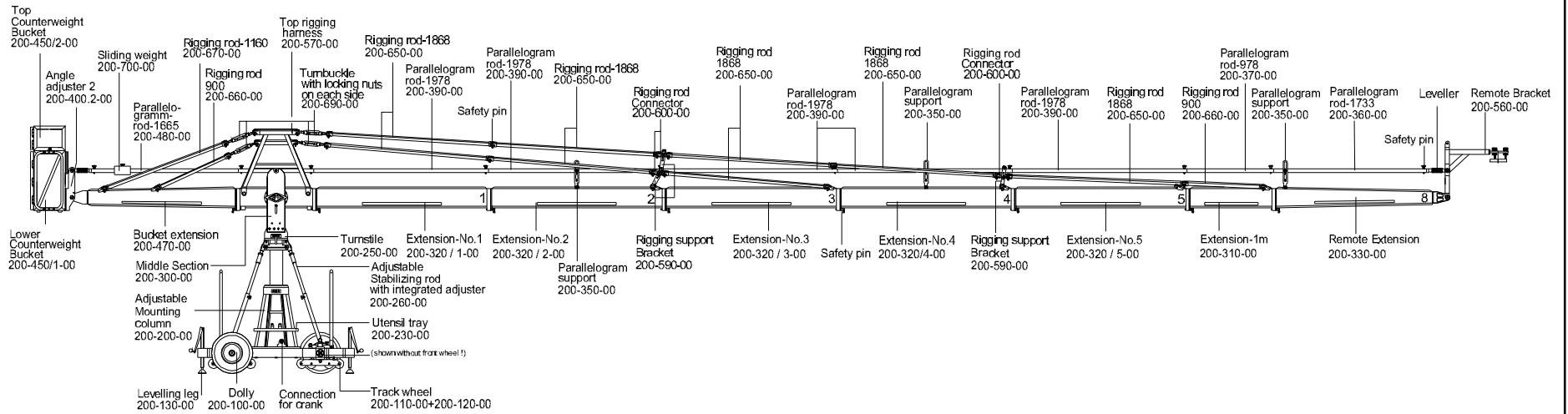

Grip Factory
Munich GmbH

Fürholzener Straße 1
85386 Eching bei München
Germany

Tel: +49 (0) 89 319 01 290
Fax: +49 (0) 89 319 01 299
www.gfm.net

GF - 16 Version 12

Name	Datum	Index	Datum	Zeichnungsnummer
Gez. Trautwig	23.01.02	e	14.10.03	200-000-12f
Gepr.		f	07.03.06	

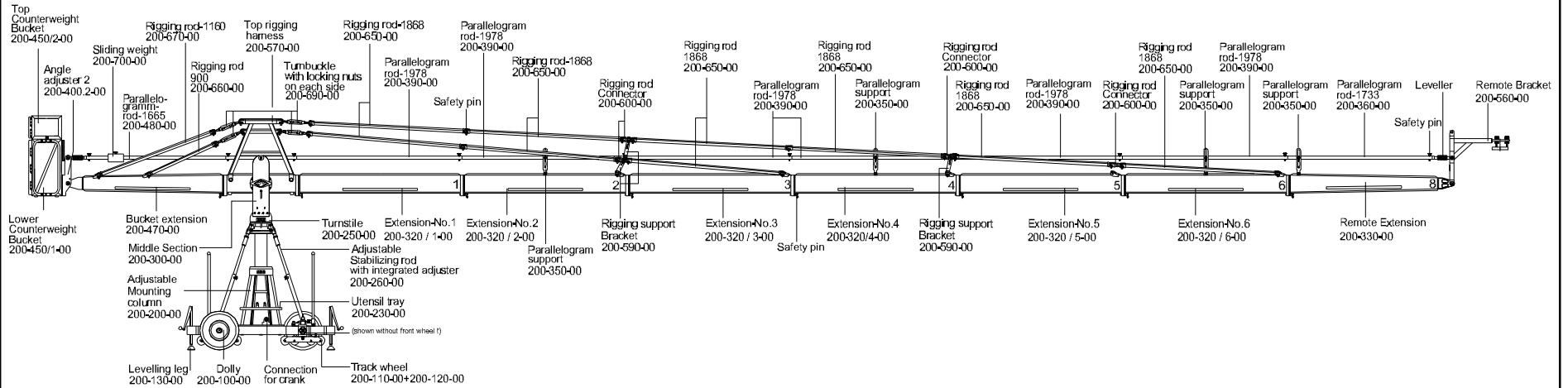

Grip Factory
Munich GmbH

Fürholzener Straße 1
85386 Eching bei München
Germany

Tel: +49 (0) 89 319 01 290
Fax: +49 (0) 89 319 01 299
www.g-f-m.net

GF - 16 Version 13

Name	Datum	Index	Datum	Zeichnungsnummer
Gez. Trautwig	23.01.02	e	14.10.03	200-000-13f
Gepr.		f	07.03.06	

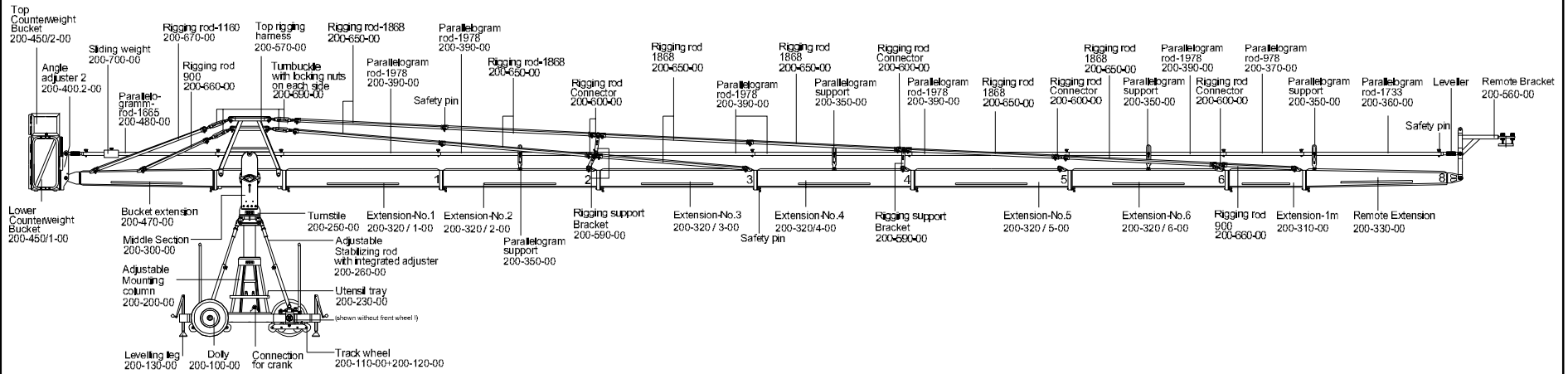

Grip Factory
Munich GmbH

Fürholzener Straße 1
85386 Eching bei München
Germany

Tel: +49 (0) 89 319 01 290
Fax: +49 (0) 89 319 01 299
www.gfm.net

GF - 16 Version 14

Name	Datum	Index	Datum	Zeichnungsnummer
Gez. Trautwig	23.01.02	f	02.11.04	200-000-14g
Gepr.		g	07.03.05	

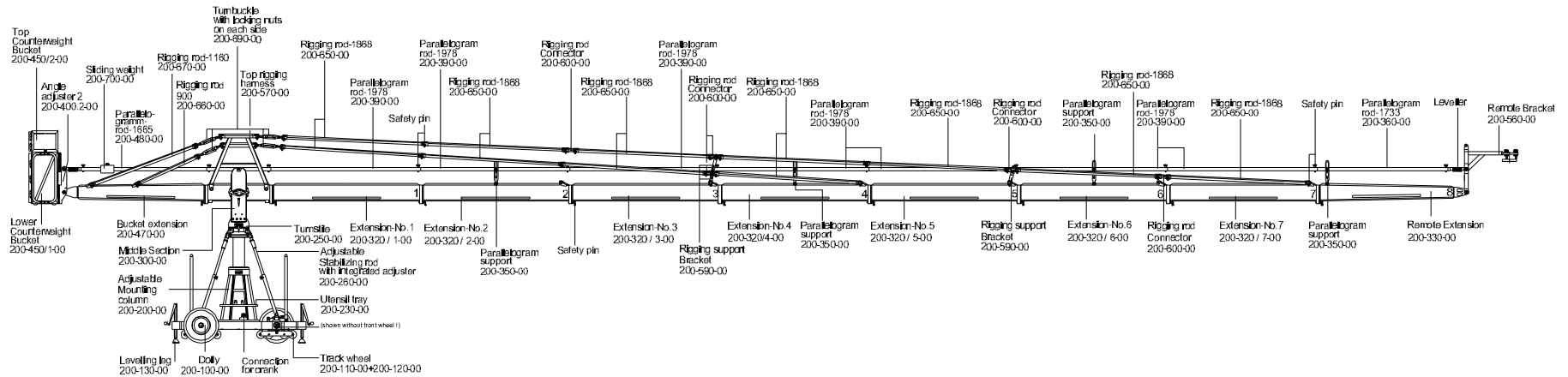

Grip Factory
Munich GmbH

Fürholzener Straße 1
85386 Eching bei München
Germany

Tel: +49 (0) 89 319 01 290
Fax: +49 (0) 89 319 01 299
www.gfm.net

GF - 16 Version 15

Name	Datum	Index	Datum	Zeichnungsnummer
Gez. Trautwig	23.01.02	f	09.08.04	200-000-15g
Gepr.		g	07.03.06	